

# MiraFount

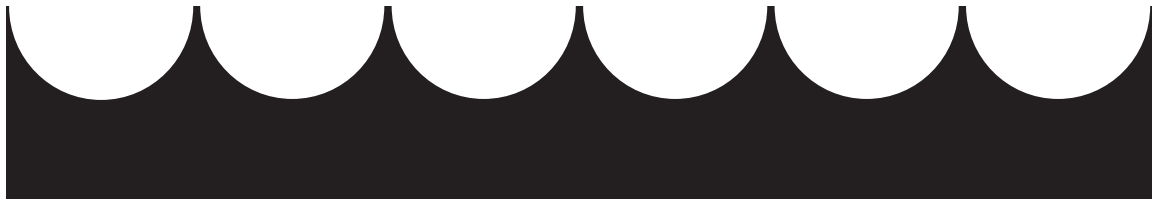

BY MIRACO



**INSTALLATION INSTRUCTIONS AND  
SPECIFICATIONS FOR MODEL 3354-S**

**READ CAREFULLY**

**MIRACO**

A DIVISION OF  
AHRENS AGRICULTURAL INDUSTRIES, INC.

BOX 686

GRINNELL, IOWA 50112

PHONE 641-236-5822

TOLL FREE 1-800-541-7866

FAX 1-641-236-3341

[www.miraco.com](http://www.miraco.com)

# SPECIFICATIONS

## PART 1 - GENERAL

### A. DESCRIPTION:

1. The MiraFount is the finest operating, lowest cost, energy-free livestock waterer on the market today. The sealed atmosphere helps prevent the formation of scum and algae. It also prevents tongue injuries from contact with frigid steel.
2. The earth temperature of the water will keep your MiraFount flowing in cold weather and also keeps the water cool in hot weather. Thermal engineering and special design of the lid closures make it work in all types of weather. Note that the earth tube should be insulated tube at least 12" in diameter and below frost. #834 Miraco heat tube is recommended.
3. All edges are curved and sloped to prevent injury to people and animals. No energy is required, eliminating the danger of electrocution and fire hazards.
4. In northern climates during cold weather a minimum of 20 head of livestock is needed to keep Mirafounts working properly.

### B. WEIGHTS & DIMENSIONS:

Model #	Capacity	Gallons	Description	Dimensions	Weight
3354-S	250 hd. beef 90 hd. dairy	70 265 liters	4-9 <sup>1</sup> / <sub>2</sub> " openings	32 <sup>1</sup> / <sub>2</sub> " x 57 <sup>1</sup> / <sub>2</sub> " x 19" 146 x 82 x 48 CM	150# 69 KG

**Note:** Capacities vary, pasture use where cattle come to water all at once will lower the number cattle this unit will water.

### C. MATERIAL NECESSARY FOR INSTALLATION:

1. Concrete
2. P.V.C. Glue
3. #834 insulated tube
4. Thread sealer or teflon tape



## PART II - MATERIALS, PRODUCTS

### A. MATERIALS:

1. High impact Rockite™ polyethylene.

### B. INSULATION:

1. The base, cover and lid closures are filled with a 3" thickness of Urethane foam.

### C. VALVE:

1. Miraco valve with stainless steel rods and poly float.

## **NOTE: FOR GRADE A DAIRY USE ONLY.**

Remove the rubber plug from the under side of the lid and insert the 3/4" PVC pipe provided. This will make your tank a non-syphon water supply for dairy. The PVC pipe is approximately 18" long and hangs down into the water from the top.

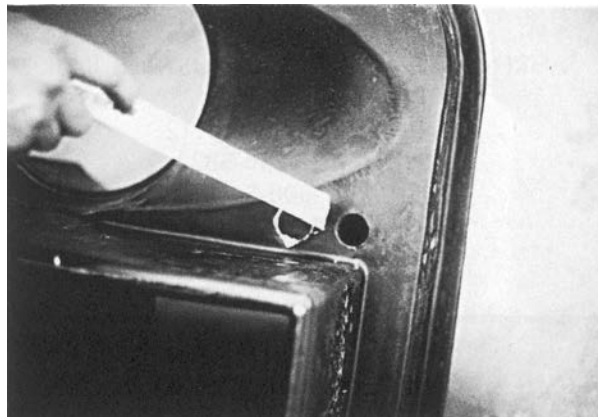

# MIRAFOUNT MODEL #3354-S INSTALLATION INSTRUCTIONS



## Step 1

Install your heat well at least 1' below frost or down to your water line to insure frost free operation. Install the water line so it comes up close to the center of the heat well. Always allow the cement to harden at least 72 hours before you continue to next steps. Place the pipe insulation over the fill line leaving it about 2" above the cement and pull the nylon tie tight so the insulation doesn't slip down.

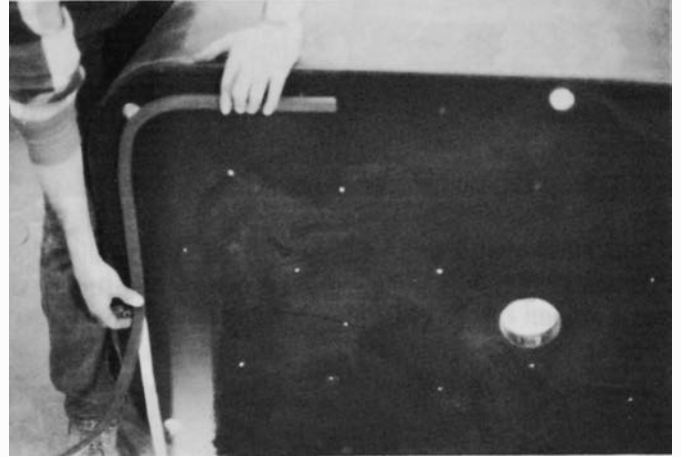

## Step 2

Clean and then stick the adhesive backed gasket to the bottom of your base.



## Step 3

Install the base clips with  $\frac{5}{16}$ " x 1" hex head bolts. Then position your base where you want it. Drill  $\frac{3}{8}$ " holes in the concrete and drive the  $\frac{3}{8}$ " x 3" anchor bolts in and secure with nuts and washers.



## Step 4

Measure down  $2\frac{3}{4}$ " from the top of the 4" pipe and make a mark on the  $\frac{3}{4}$ " fill line.

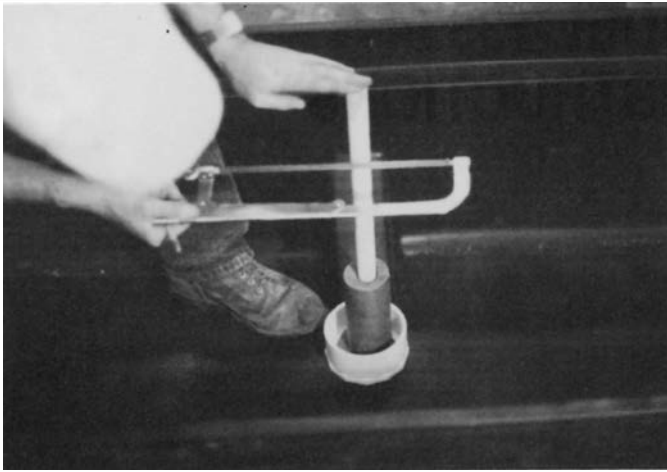

**Step 5**

Remove the 4" pipe and set aside. Cut off the 3/4" fill line at your mark. Remove all filings and clean the outer surface of the 3/4" pipe.

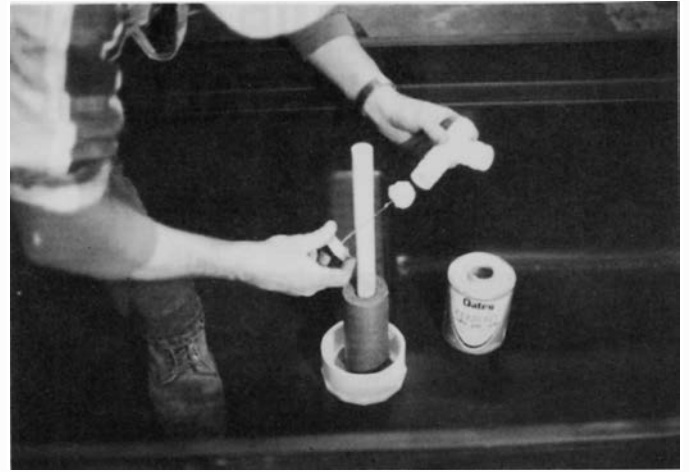

**Step 6**

After using pipe thread sealer or teflon tape on all the threaded fittings and tightening them, apply PVC pipe glue to the slip fitting and secure to the 3/4" fill line.

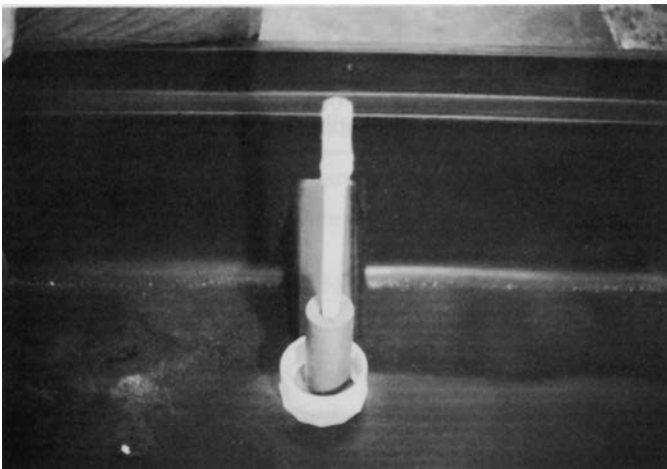

**Step 7**

Make sure when you glue the fittings in place it is pointed straight across the tank parallel with the end walls.



**Step 8**

Apply PVC pipe glue to the 4" pipe and glue into the fitting in the bottom of the base.



**Step 9**

Push the 4" pipe into place so the 3/4" pipe fittings come through the hole in the 4" pipe.



**Step 10**

Apply thread sealer or teflon tape to the threads on the valve.



### Step 11

Screw the valve in tight against the 4" pipe. Hand tight should be enough.

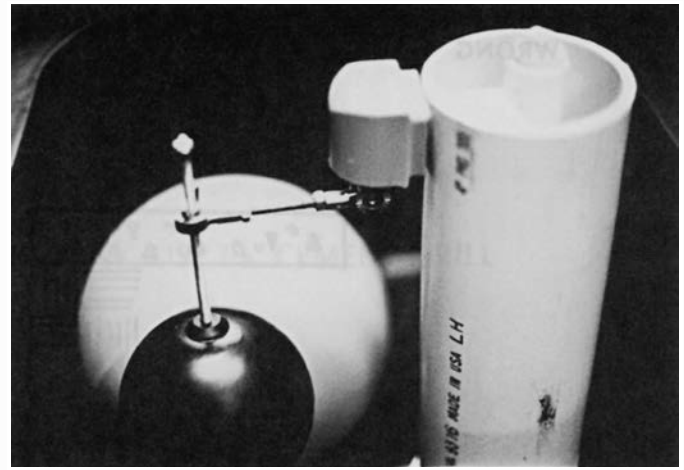

### Step 12

Attach the float assembly to the lower arm of valve using the  $\frac{1}{4}$ " thumb screw in the parts bag. Place drain plugs in drain holes from the inside only. Place balls in bottom of waterer's base, begin filling. Install top of waterer to base. The final adjustment should be made through access post in the top. Proper water level is achieved when ball just touches the underside of the lid. Leaving them a little loose is recommended.

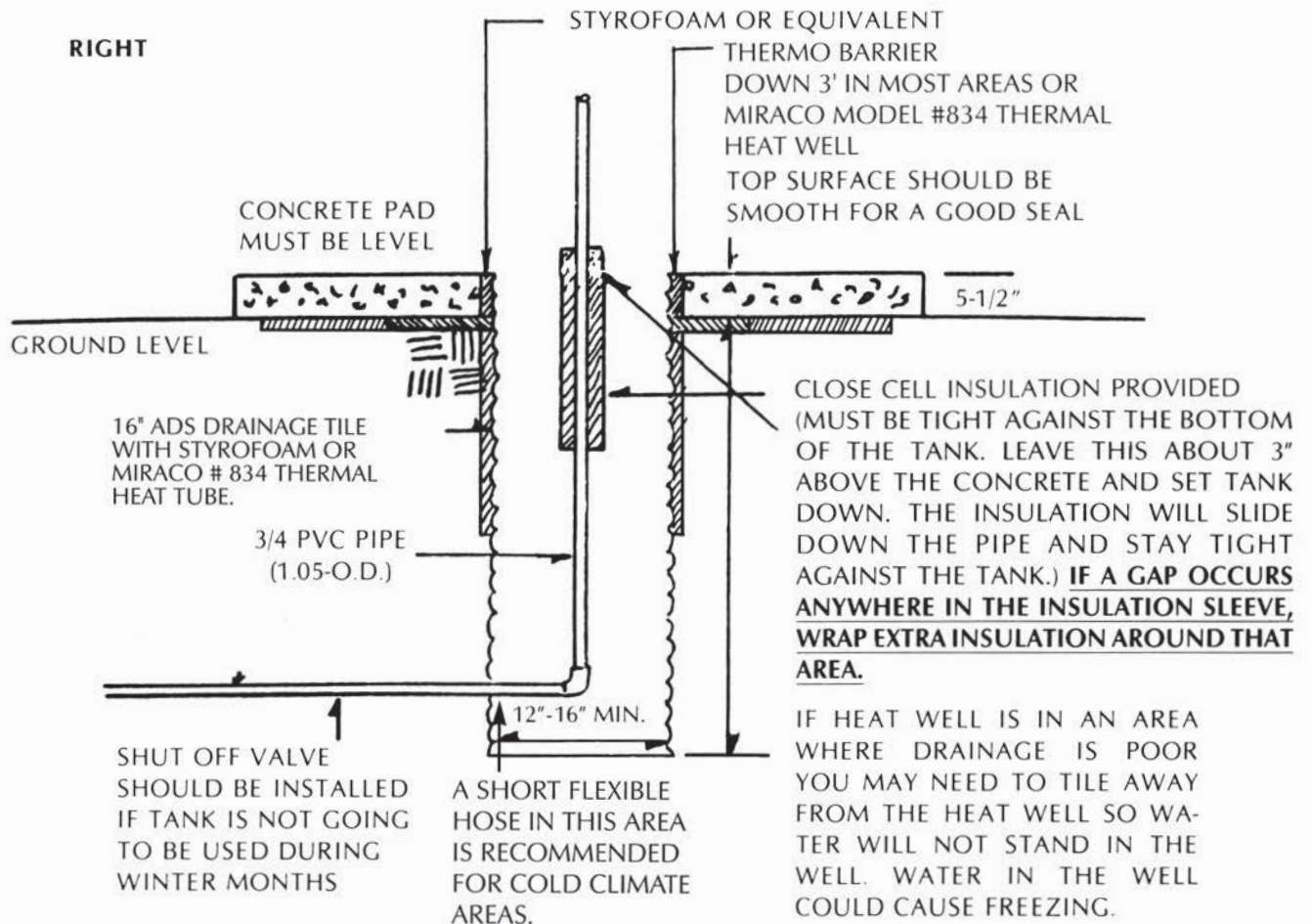

WRONG

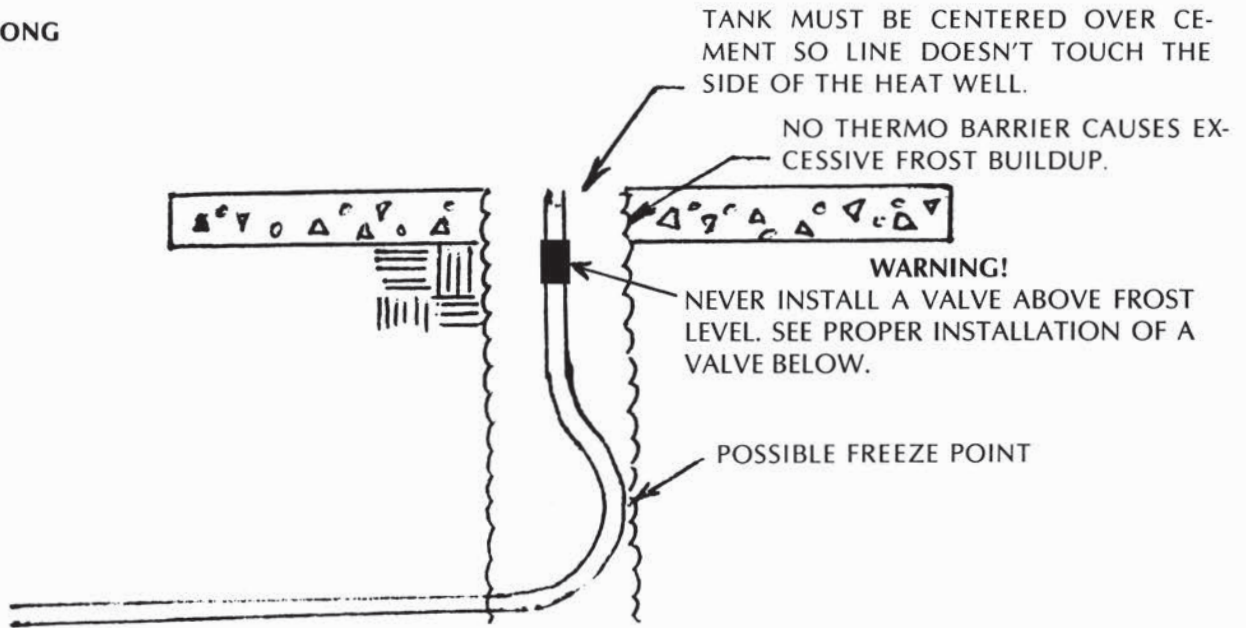

## PROPER INSTALLATION OF DRAIN BACK SHUTOFF VALVE

RUN THIS ROD THROUGH THE VENT PIPE IN THE WATERER. WELD A LARGE HEX NUT ON TOP, SO A WRENCH CAN BE USED TO SHUT OFF THE WATER BELOW.

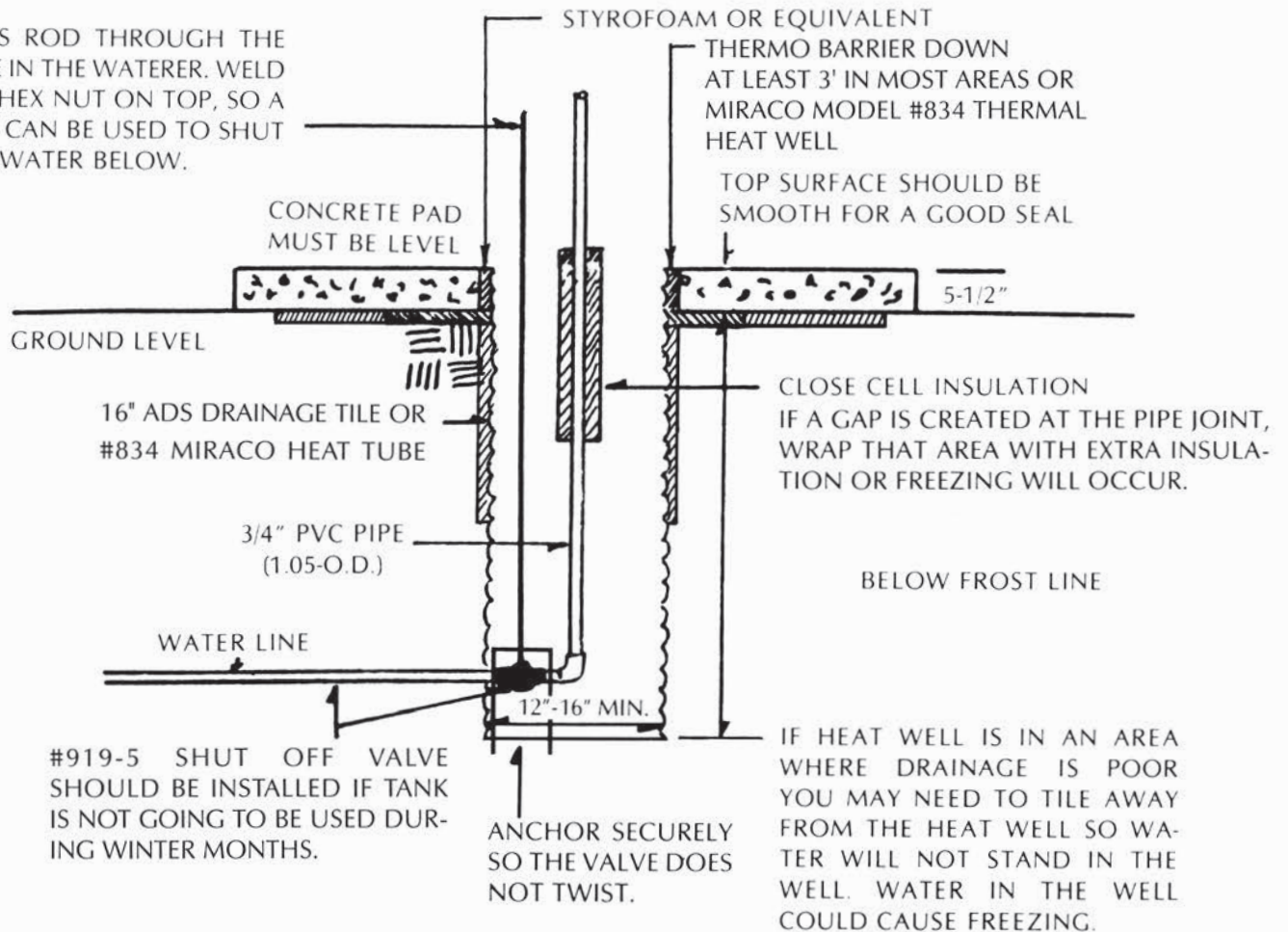

# BASE AND ANCHOR PLATE DIMENSIONS FOR 3354-S

DRILL ANCHOR BOLTS IN AFTER SETTING TANK. USE  $\frac{3}{8}$ " CEMENT DRILL

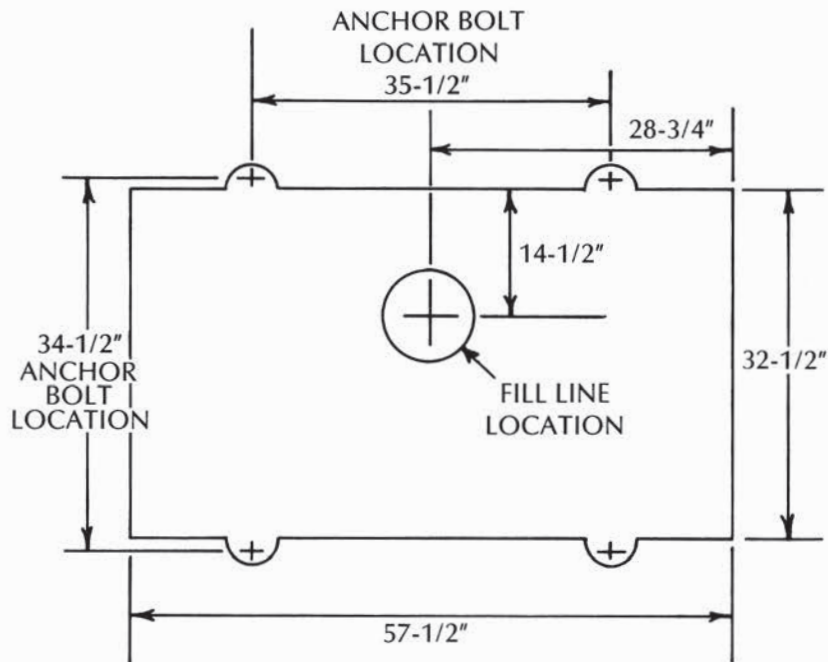

MODEL #3354 & 3354-S

## MODEL 3354-S MANAGEMENT TIPS FOR THE MIRAFOUNT LIVESTOCK THERMOS

1. A fiberglass rod is to be used to hold the balls back for training livestock. The fiberglass rod is inserted into a hole in the baffled portion of the lid. This holds the balls back for training.
2. For short periods of time when you're not using the MiraFount in winter, you can dip 3-5 gallons of water out every day and the tank will sustain itself until livestock are using it again. If you plan on not using it for a long time, merely drain it and shut off the water. This is where the shut off valve comes in handy.
3. Water level is very important. If the water is too high the balls will stick shut in the winter time and the tank will appear frozen. A kick or a small amount of hot water on the balls will fix the problem. Then lower the water level so this won't happen again. However, never lower water below the baffle or cold air could go under and freeze your valve.
4. In case of power failure, merely keep the livestock away from the waterer so they can't drink it down. If this has already happened, then a small amount of hot water is all you need. **NEVER USE AN OPEN FLAME TO THAW ICE!**
5. Management is necessary in any operation and this includes checking your waterer daily. Water is very important and any malfunction should be attended to immediately. This is good practice for any make of waterers.
6. MiraFounts must be installed level, otherwise one ball will be higher than the others.
7. The MiraFount should be cleaned periodically, especially the ones being used for hogs. Mud can hamper the proper operation of the MiraFount since the balls have to move freely in order to have proper operation.
8. If your valve is seeping, check the valve for foreign materials first. This is the biggest cause of seeping valves. If you have extremely rusty water or dirty water, your valve should be cleaned periodically.
9. If you have any questions give us a call at 641-236-5822.
10. If valve persists on leaking, use an allen wrench to tighten the orifice under the plunger. Turn clockwise to tighten.
11. Drain plugs are to be placed inside the tank to plug the drain hole.

## **Miraco Livestock waterers Express warranty and Waiver of implied warranties and consequential damages**

### **Express Warranty**

Ahrens Agricultural Industries Co. , dba Miraco, expressly warrants that the Miraco waterers (excluding valve and valve parts) will be free of defects in materials and workmanship for a period of five (5) years from delivery. The Miraco valve and valve parts are warranted to be free of defects in materials and workmanship for a period of one (1) year from delivery. Such warranty does not apply to any Miraco unit that has been subjected to misuse, or material failure to install, operate or maintain in accordance with Miraco's written instructions, or other events acts or omission, including but not limited to acts of nature, which affect the Miraco unit materially and adversely and are not attributable to Miraco.

This warranty is limited to the repair or replacement of the defective part, at the option of Miraco. Such repair or replacement part is warranted only for the unexpired portion of the original warranty period. Buyers with warranty claims should contact their local dealer immediately.

Heaters in all electrically heated units are warranted for a period of one (1) year.

### **Waiver of implied warranties and Consequential damages**

Except for the above express warranty, this product is sold as is. Implied warranties of merchantability and fitness for a particular purpose, as well as special, indirect or consequential damages, are all waived by the buyer.